



NOTABLE

ICF

NoTable

"The NoTable collection interprets the essence of the table with something extra: a great dynamic nature that makes it possible to multiply the space in which it is used".

Design: Norbert Geelen



All around the base

There is nothing simpler than a table's structure: a top that rests on a base. Yet so much simplicity can mean designs of great personality which create clear impression to the space in which they are placed. NoTable, the latest ICF tables collection, it is a concrete example. The result of careful design and functionality research, NoTable is an all-around product with a strong expressive personality, which remains sleek and elegant.

Non c'è nulla di più semplice della struttura di un tavolo: un piano che poggia su una base. Eppure così tanta semplicità può dare origine a forme di grande personalità che conferiscono una chiara impronta allo spazio in cui sono inserite. NoTable, ultimo nato della collezione tavoli di ICF, ne è un esempio concreto. Frutto di un'attenta ricerca in termini di design e funzionalità, NoTable si configura come un prodotto all-around, dalla forte personalità espressiva, pur mantenendo una forma lineare ed elegante.



Dynamic office areas

Speed, flexibility and the ability to maximise every individual opportunity: these are the key concepts around which we have designed NoTable. A program of tables dedicated to executive and operational offices, to meeting and conference areas. The result is an extremely versatile system of tables and desks that is easily transformable and can change application in just a few minutes: from height adjustable workstations to meeting tables and complex solutions which, combined with one another, create conference spaces that can be easily dismantled and stored.

The table's focal point is its base which was conceived as the union of several main elements, but separated from each other to provide the product's character. The combination of the various elements has a harmonious and pleasant result and is ideal for any kind of space, operations or executive office, from a simple meeting room to a larger conference room.

Velocità, flessibilità, capacità di massimizzare ogni singola occasione: sono questi i concetti chiave intorno ai quali abbiamo progettato NoTable un progetto dedicato agli uffici direzionali e operativi, alle zone riunioni e conferenze. Il risultato è un sistema di tavoli e scrivanie estremamente versatile, capaci di trasformarsi cambiando utilizzo in pochi minuti: dalle postazioni singole regolabili in altezza, ai tavoli riunione, alle postazioni più articolate, abbinabili tra loro per creare spazi conferenza che poi vengono dissassemblati e immagazzinati con facilità.

Il punto focale di NoTable è proprio il suo basamento, concepito come l'unione di vari elementi portanti, ma visualmente scorporati l'uno dall'altro per renderli protagonisti del prodotto. La combinazione dei vari elementi ha un risultato molto armonioso e piacevole, ideale per essere collocato in qualsiasi tipo di spazio, dall'ufficio operativo a quello executive, dalla sala riunioni semplice a una più grande sala conferenze.

Outstanding **versatility**

NoTable is a system of tables which offers countless interpretations: it responds to a variety of professional needs with maximum efficiency to become an executive desk, a double desk, a multistations work area, and a meeting table of various sizes. Development and research have always been a priority at ICF. This allows us to create user-friendly products. We try to design products that are functional, but above all comfortable, that can be used by a variety of individuals with different needs, but with the same purpose: to work comfortably, personalising one's own workstation to reach the highest level of well-being. We have always paid the utmost attention to ergonomics, to adjustability and personal settings of seats and, now, even our table collections are adjustable and transformable, in order to make the work environment as pleasant as possible, in both aesthetic and practical terms.

NoTable è un sistema di tavoli che può essere variamente interpretato: a seconda delle esigenze professionali, risponde sempre con la massima efficienza, diventando scrivania direzionale, scrivania doppia, zona di lavoro a molteplici postazioni, tavolo riunione di diverse dimensioni.

Sviluppo e ricerca sono da sempre prioritari in ICF e ci consentono di ideare prodotti user-friendly. Cerchiamo di progettare prodotti funzionali ma soprattutto comodi, che possano essere fruite da persone con necessità diverse tra loro, ma con il medesimo scopo: lavorare in maniera confortevole, personalizzando la propria postazione lavoro per avere il massimo benessere.

Da sempre prestiamo particolare attenzione all'ergonomia, alla regolazione e alla personalizzazione delle sedute e, ora, anche le nostre collezioni di tavoli sono regolabili e trasformabili per rendere l'ambiente lavorativo il più piacevole possibile, sia da un punto di vista estetico che pratico.



NoTable

MANAGER DESK



Balance of shape

Every detail of the NoTable speaks of hidden sophistication behind apparent simplicity. Die-cast aluminium legs stem dynamically from the floor to give the table its remarkable lightness. The table legs are attached to a tubular frame with an adjustable incline to showcase the high quality of NoTable's discretely cutting-edge framework.

Its contoured surface is available in barrel, oval and rectangular shapes of various sizes and assorted finishes for a wide selection of styles. The table-edge perimeter is available with a unique inverted section (ENT edge) in a range of finishes. The table's construction allows the creation of customized surfaces.

Ogni dettaglio del tavolo NoTable racconta la complessità che si nasconde in una semplicità soltanto apparente. Le gambe sono realizzate in pressofusione di alluminio ed hanno una linea affusolata che rende lo stacco da terra particolarmente dinamico, dando una sensazione di grande leggerezza al tavolo. Le gambe sono applicate al tubolare verticale con un'inclinazione variabile a dimostrare come la costruzione di NoTable sia sostenuta da una tecnologia discreta ma di altissimo livello.

Il piano sagomato è previsto nelle versioni a botte, ovale e rettangolare in diverse misure e in finiture che conducono ad interpretazioni stilistiche differenti. Il bordo perimetrale del piano può avere una caratteristica sezione a becco rovesciato (bordo ENT) ed è disponibile in varie finiture. La costruzione della struttura consente di realizzare anche piani su misura.



—
Simplicity and elegance come together
to create a uniquely formed desk that gives
any office space a surprising touch all its own
—



Add style to **functionality**





—
NoTable is an all-around product
with a strong expressive personality,
which remains sleek and elegant
—

Personal work-equipment



Development and research have always been a priority at ICF. This allows us to create user-friendly products. We try to design products that are functional, but above all comfortable, that can be used by a variety of individuals with different needs, but with the same purpose: to work comfortably, personalising one's own workstation to reach the highest level of well-being.

Sviluppo e ricerca sono da sempre prioritari in ICF e ci consentono di ideare prodotti user-friendly. Cerchiamo di progettare prodotti funzionali ma soprattutto comodi, che possano essere fruite da persone con necessità diverse tra loro, ma con il medesimo scopo: lavorare in maniera confortevole, personalizzando la propria postazione lavoro per avere il massimo benessere.



68 cm



We have always paid the utmost attention to ergonomics, to adjustability and personal settings of seats and, now, even our table collections are adjustable and transformable, in order to make the work environment as pleasant as possible, in both aesthetic and practical terms.

Da sempre prestiamo particolare attenzione all'ergonomia, alla regolazione e alla personalizzazione delle sedute e, ora, anche le nostre collezioni di tavoli sono regolabili e trasformabili per rendere l'ambiente lavorativo il più piacevole possibile, sia da un punto di vista estetico che pratico.

Thinking about **personal** "work-equipment"

9.15 AM Organize daily agenda

Table top height 74 cm

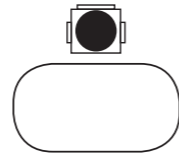

2.00 PM Meet with client

Table top height 72 cm

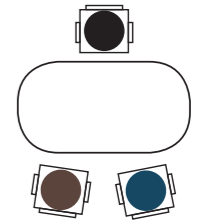

10.30 AM Stand-up meeting

Table top height 105 cm

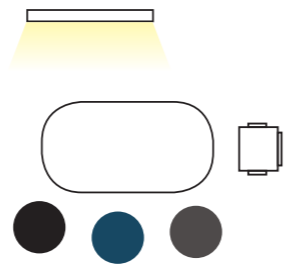

5.50 PM Short stand-up work for well-being

Table top height 110 cm

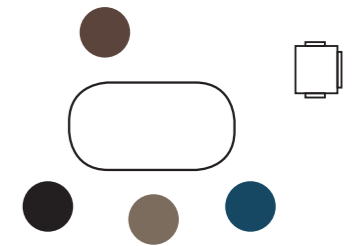

Shapes, dimensions and finishes

RECTANGULAR



TABLE TOP

- 180 cm x 110 cm
- 220 cm x 110 cm
- 240 cm x 110 cm
- 280 cm x 110 cm

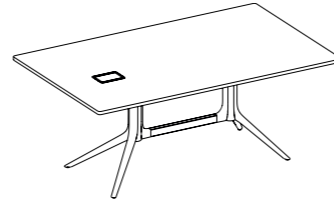

OVAL



TABLE TOP

- 200 cm x 125 cm
- 220 cm x 125 cm
- 240 cm x 135 cm

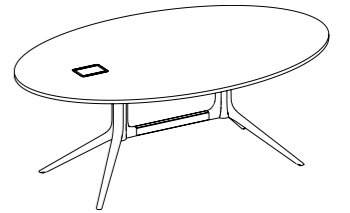

BARREL



TABLE TOP

- 180 cm x 110 cm
- 220 cm x 110 cm

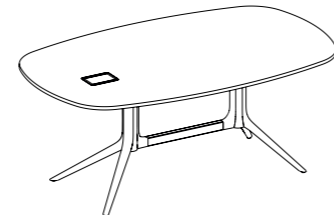

FINISHES TOP

HPL



White

POWDER COATED



White

VENEER



Oak

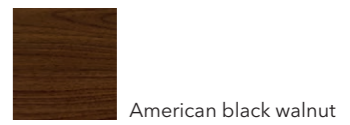

American black walnut

FENIX



Black



Dark grey



Warm grey



Light grey

Integrated electrification

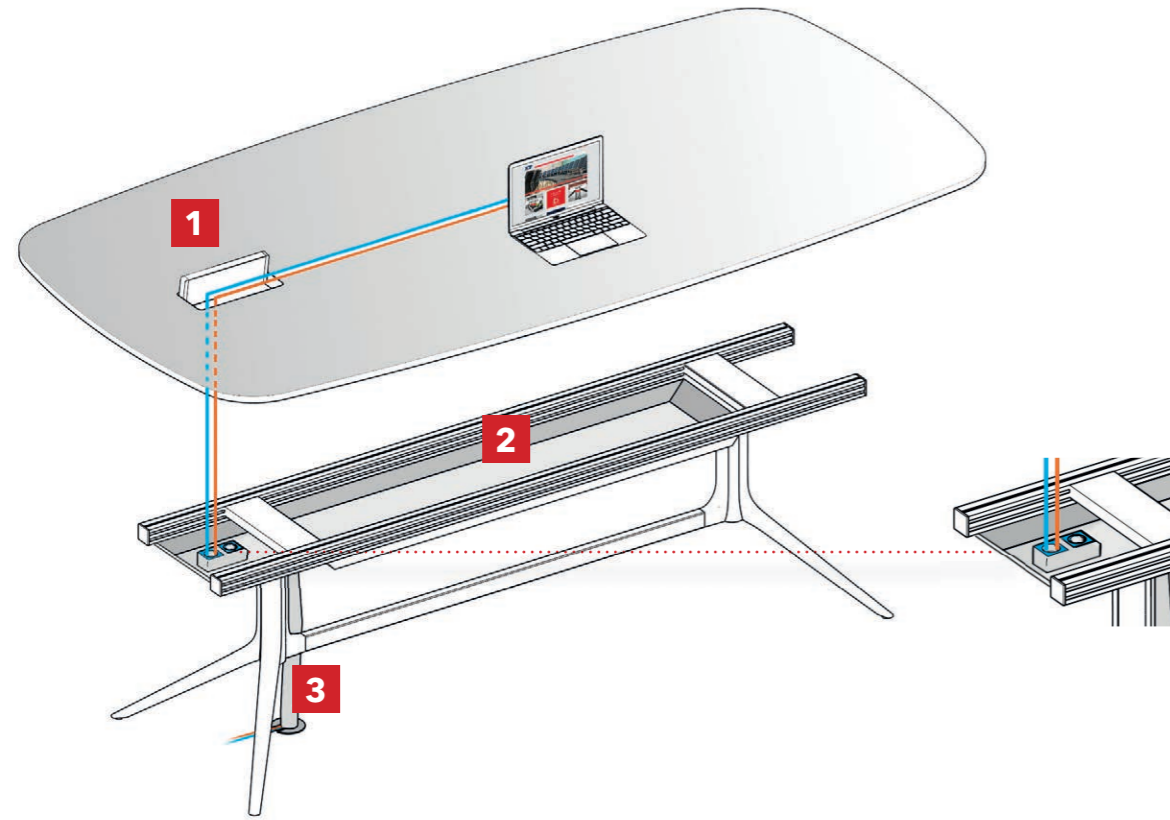

1 Flip door **2** Network cable **3** Fabric cable duct — Electrical cable — Network cable

ALUMINIUM FLIP DOOR WITH INNER FINISH

VENEER



American black walnut
Oak

HPL



White

FENIX



Black
Dark Grey Warm Grey
Light Grey

POWDER COATED



White

OPTIONAL ELECTRICAL PLUGS



Coni cover plug



Twist plug



Coni plug



Elevator plug

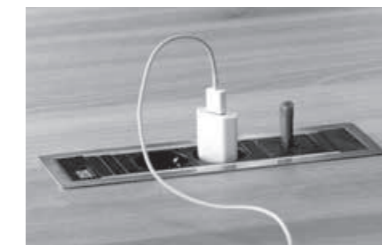

Power frame plug



Conference plug

NoTable
MEETING



A strong formal identity

NoTable is the perfect answer to the changing functional and appearance requirements of the modern meeting areas. Since the beams can be connected at different angles, the system is remarkably flexible. When space, shape or organizational requirements in the office change - either temporarily or permanently - the system can meet such requirements perfectly by adapting to the new conditions.

NoTable combines technology with fine design, and strength with lightness. It's a system that offers great precision, pure shapes highlighted in elegant solutions, and materials with a strongly modern connotation, such as Fenix, HPL laminate and aluminum. NoTable is the attractive, yet technically sophisticated conference table.

NoTable è la risposta perfetta al variare delle esigenze estetiche e funzionali delle moderne sale riunioni.

La flessibilità del sistema è notevolmente ampliata dalla possibilità progettuale di collegare le barre con differenti angolature. In questo modo, al variare anche temporaneo delle esigenze di spazio, di forma o di organizzazione all'interno dell'ufficio, il sistema risulta in grado di rispondere perfettamente alle richieste, adeguandosi alle mutate condizioni.

NoTable rappresenta la sintesi tra tecnologia e design, tra forza e leggerezza. Un progetto caratterizzato dal grande rigore, la purezza delle forme evidenziate da soluzioni particolarmente ricercate, l'impiego di materiali quali Fenix, laminato HPL e l'alluminio fortemente connotati in senso moderno: NoTable è un tavolo riunioni ad alto contenuto tecnico e formale.

NoTable
MEETING

—————
NoTable combines technology
with fine design, and strength
with lightness
—————



—
A project designed around new ways of
working in the office environment: flexible
and dynamic, innovative and modern
—





It's a system that offers
great precision, pure shapes
highlighted in elegant solutions



Consistently creating
the best meeting conditions



As **simple** as a **circle**



Height-up meeting

Even the longest and most demanding of meetings becomes an experience in comfort. NoTable's Height Adjustable version is equipped with a special mechanism to adjust its height with the simple push of a button. Whatever your needs, its resting surface can be adjusted from 68 cm to a maximum of 130 cm, to reach stand-up position.

NoTable thus adapts easily to its users' comfort and any needs that arise. In an ever-changing and versatile office space, success is flexibility that gives a sense of well-being and comfort.

Anche una riunione lunga e impegnativa può trasformarsi in un'esperienza di comfort: NoTable nella versione Height Adjustable è infatti equipaggiato con uno speciale meccanismo che permette di modificarne l'altezza semplicemente premendo un tasto.

Qualsiasi sia l'esigenza, l'altezza del piano di appoggio può variare da 68 cm a un massimo di 130 cm, fino a raggiungere una posizione stand up. In questo modo, le dimensioni di NoTable si adattano perfettamente alle esigenze di comodità degli utilizzatori, ma anche alle particolari necessità di utilizzo che si dovessero presentare. Perché in uno spazio ufficio dinamico e versatile la scelta vincente è riuscire a essere flessibili, assicurando però al tempo stesso, benessere e comfort.



Stand-up meeting

Reacting to everyday challenges with quick decision-making skills requires instruments that measure up to high standards. Today's meetings are more and more dynamic and functional and NoTable Stand Up was created with this extreme dynamism in mind. It is a table for gathering around, brainstorming and finding quick solutions without even having to sit down. And all in perfect comfort. NoTable Stand Up is even ideal for informal meetings, as well as canteen and reception areas. Its linear, sleek shape gives a strong aesthetic impact to make it the focal point of any office space.

La capacità di reazione alle problematiche di ogni giorno e la velocità nel prendere decisioni richiedono strumenti di lavoro adeguati. Ecco perché anche i momenti di riunione sono diventati particolarmente dinamici e funzionali: NoTable Stand Up è stato ideato proprio per rispondere a un'esigenza di dinamismo estremo in cui mettersi intorno a un tavolo per pensare, discutere o prendere decisioni all'insegna della rapidità senza nemmeno sedersi, eppure in tutta comodità. NoTable Stand Up è anche ideale per riunioni informali, aree caffetteria o accoglienza. La sua forma lineare e slanciata lo rende di forte impatto estetico, un elemento focalizzante all'interno dello spazio ufficio.



—
Tradition or stand-up a high
tech meeting table
—

Flexible in length

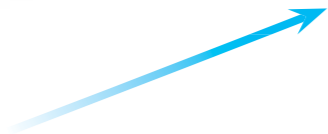

One way

Versatility and flexibility are key features of the NoTable system. The individual but common components create the ability to conceive tailored solutions of any shape or dimension in order to meet specific requirements without limitation. Beams are able to connect to each other with different inclination degrees.

La versatilità e la flessibilità rappresentano contenuti progettuali del sistema NoTable. Infatti, i suoi elementi offrono la possibilità di realizzare composizioni speciali di qualsiasi forma e dimensione, di creare soluzioni particolari concepite espressamente sulle specifiche esigenze, scegliendo liberamente le finiture all'interno di tutta la gamma disponibile. Le traverse possono essere connesse le une alle altre con differenti angoli di inclinazione.

Flexible in width

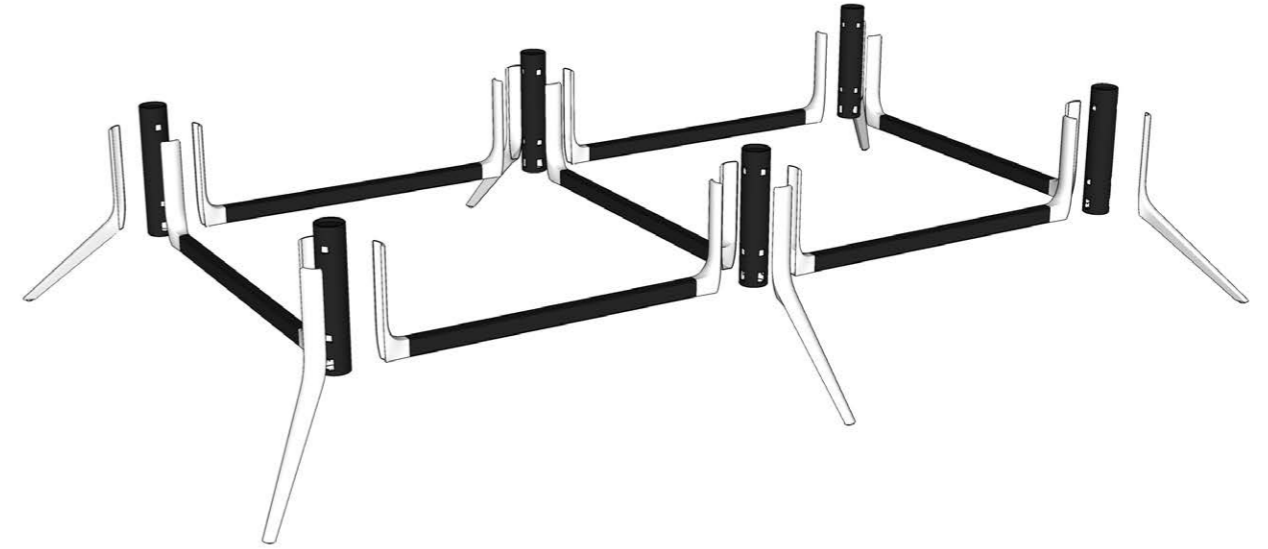

Two way

NoTable is a system that can be changed continuously because it's based on a structural element - namely, a vertical tubular - that can be used individually or combined with other tubulars. All the components in the system are connected to the beam: whenever there is a need to expand the number of workstations or to modify their functions or appearance.

NoTable è un sistema che si presta a continue trasformazioni perché si sviluppa attorno ad un elemento strutturale, il tubolare verticale, che può essere utilizzato singolarmente o in combinazione con altri tubolari trasversali. Ad essa si connettono tutti i componenti del sistema: in qualsiasi momento si dovesse presentare la necessità di ampliare il numero di postazioni o mutarne le caratteristiche funzionali o estetiche.

Shapes, dimensions and finishes

ROUND



TABLE TOP

Ø 90 cm
Ø 120 cm
Ø 140 cm
Ø 160 cm

2 SECTOR

Ø 210 cm



BARREL



TABLE TOP

200 cm x 100 cm
200 cm x 120 cm
240 cm x 120 cm
280 cm x 130 cm

2 SECTOR

320 cm x 130 cm
380 cm x 130 cm
440 cm x 130 cm

3 SECTOR

500 cm x 140 cm



SQUARE

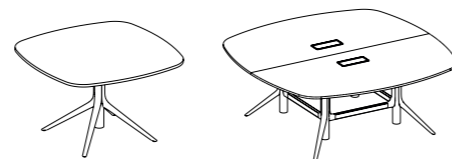

TABLE TOP

90 cm x 90 cm
120 cm x 120 cm
140 cm x 140 cm
160 cm x 160 cm

2 SECTOR

200 cm x 200 cm



FINISHES TOP

MELAMINE



White

POWDER COATED



White

VENEER



Oak

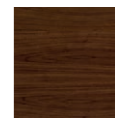

American black walnut

Integrated electrification

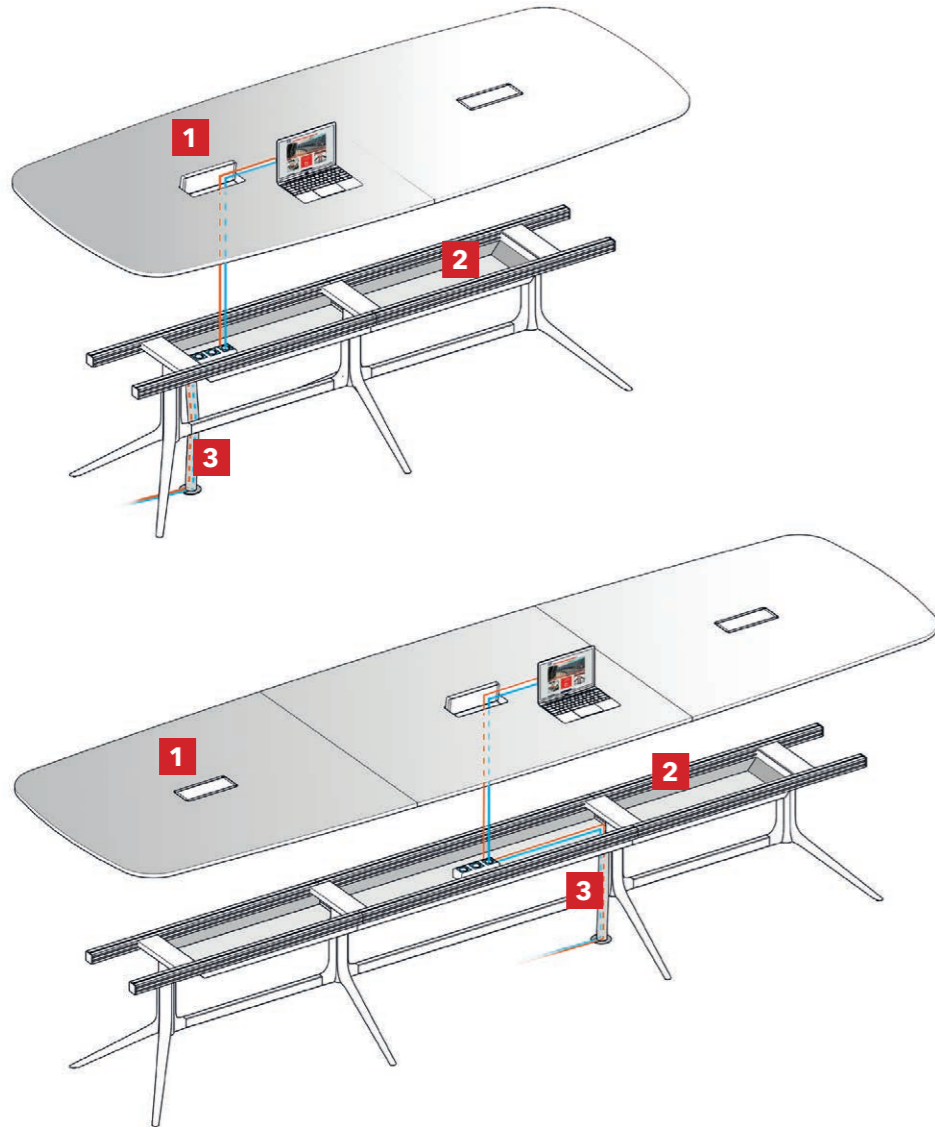

- Power
- Data
- 1** Flip door
- 2** Raceway cable
- 3** Vertical cable duct

- Power cable
- Data
- 1** Flip door
- 2** Raceway cable
- 3** Vertical cable duct

ALUMINIUM FLIP DOOR WITH INNER FINISH

VENEER



American black walnut
Oak

MELAMINE



White

POWDER COATED



White

OPTIONAL ELECTRICAL PLUGS



Coni cover plug



Twist plug



Coni plug



Elevator plug

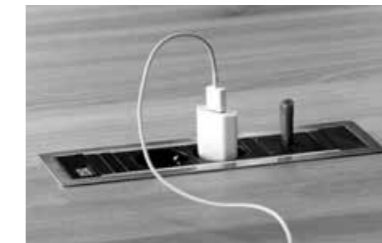

Power frame plug



Conference plug

NoTable
FOLDING

Multiply your space



NoTable Folding offers multiple solutions dedicated to meeting areas - whether they are conference rooms, training areas, multifunction meeting areas, and even lobbies or cafeterias - multiplying the available space in a quick and easy manner.

Notable Folding is a collection that is wealthy not only in terms of state-of-the-art solutions, but also of its distinctive character, where each element is knowledgeably gauged and appreciated. The design of the legs echoes the elegance and linear nature of the Notable tables, in which the load-bearing elements of the base are de-structured and then artfully combined, giving the whole structure strength and stability. The top is designed in various finishes and carefully shaped and structured: although it is solid, at the same time it is light and easy to handle, and it may be inclined and closed in an instant thanks to a mechanism that is easy to use.

In un contesto lavorativo sempre più dinamico e flessibile, anche lo spazio ufficio ha costantemente bisogno di soluzioni innovative e performanti. Nasce così Notable Folding una collezione di tavoli pieghevoli, dal design accattivante e di estrema versatilità. Notable Folding è una collezione ricca non solo di soluzioni all'avanguardia, ma di un suo carattere distintivo, dove ogni elemento è sapientemente dosato e valorizzato. Il design delle gambe riprende l'eleganza e la linearità dei tavoli Notable in cui gli elementi portanti del basamento sono destrutturati e poi accostati con maestria, conferendo all'intera struttura forza e stabilità. Il piano è pensato in diverse finiture e curato sia nella forma che nella struttura: pur essendo solido è allo stesso tempo leggero e facile da maneggiare e può essere inclinato e chiuso in un attimo grazie a un meccanismo di semplice utilizzo.





Folding table

NoTable Folding offers multiple solutions dedicated to meeting areas - whether they are conference rooms, training areas, multifunction meeting areas, and even lobbies or cafeterias - multiplying the available space in a quick and easy manner. In the same room, therefore, one can create meeting areas of various dimensions and types, which can be changed at a moment's notice. The tables can be set out with light and stackable chairs, to be used as needed.

Notable Folding offre una molteplicità di soluzioni dedicate alle aree meeting - che si tratti di spazi conferenza, zone training, aree riunione multifunzione e addirittura lobby, caffetterie o mense - moltiplicando lo spazio disponibile in modo facile e veloce. Nello stesso ambiente si possono ricavare quindi aree meeting di varie dimensioni e tipologia che possono essere modificate con estrema rapidità. I tavoli possono essere corredati da sedie leggere e impilabili, da utilizzare a seconda della necessità.



—
The quality of its
the materials used
—

and Folding desk

The collection includes tables of various dimensions, which can be easily reconfigured in a few instants, from traditional work stations to more or less divided meeting rooms in a variety of sizes. In Notable Folding, careful design research has sought to combine practicality and aesthetics, reinterpreting, in a modern form, a product that, until now, has been considered simply functional, without particular attractions in terms of appearance.

La collezione comprende tavoli di varie dimensioni riconfigurabili in pochi istanti in postazioni lavoro tradizionali oppure in sale riunioni più o meno articolate e di grandi dimensioni. Un'attenta ricerca progettuale ha cercato di coniugare in Notable Folding praticità ed estetica, reinterpretando in chiave moderna un prodotto finora ritenuto semplicemente funzionale ma privo di particolari attrattive dal punto di vista della linea.



Stand-up and Folding

But that is not all of it. Notable Folding is also designed in a stand-up version - a high table, ideal for fast meetings or to be positioned in cafeteria areas, offering an even more versatile solution, ideal for the latest needs in office spaces. Equipped with four wheels, it is easy to move, to position, and to close again after use. It is perfect accompanied by high chairs or stools, giving an original look to its surroundings. Each table can be equipped with an integrated wiring system for maximum functionality, and can be equipped with accessories such as screens and knee-cover panels. Thanks to the in-line top-hooking system, it is truly easy to reconfigure the space into stations of various dimensions, also including electrical and multimedia systems with ease.

Ma non è tutto: Notable Folding è stato pensato anche nella versione stand up, un tavolo alto ideale per riunioni veloci o da inserire in zone caffetteria, offrendo una soluzione ancor più versatile e mirata alle nuove esigenze dello spazio ufficio. Equipaggiato con quattro ruote è facile da spostare, da posizionare e poi richiudere al termine dell'utilizzo. E' perfetto per essere accompagnato da sedie alte o sgabelli, conferendo un tocco di originalità all'ambiente in cui è inserito. Ogni tavolo può essere dotato di un sistema di cablaggio integrato per una massima funzionalità e può essere equipaggiato con accessori come schermi e pannelli copri ginocchia. Grazie a un sistema di aggancio tra i vari piani in linea è davvero facile riconfigurare lo spazio in postazioni di diverse dimensioni, integrando anche i sistemi elettrici e multimediali senza problemi.

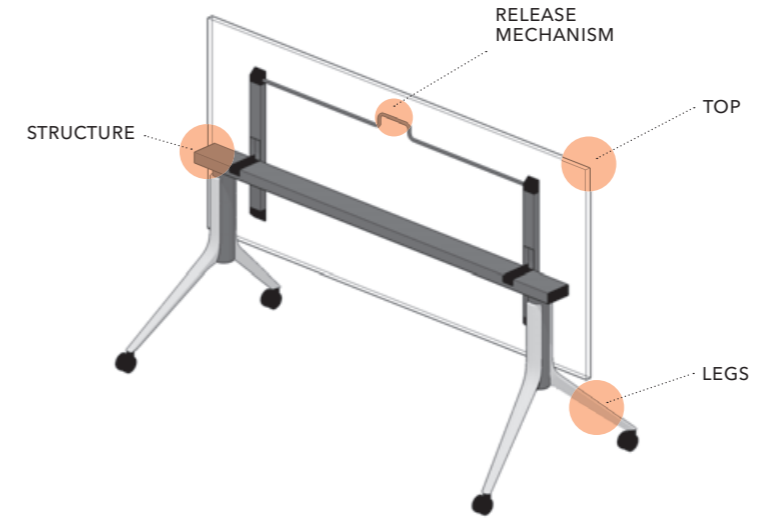

Once folded, the tables are easy to handle. They are equipped with wheels and can be joined and then put away in the meeting room itself or in a warehouse, taking up very little space.

Una volta piegati, i tavoli sono facili da maneggiare, sono dotati di ruote e possono essere riuniti e poi riposti sia nella sala riunioni stessa sia in un magazzino con un ingombro minimo.

STAND UP / ALTEZZA REGOLABILE H 105 MM



One room, many solutions 1

Monday - conference room

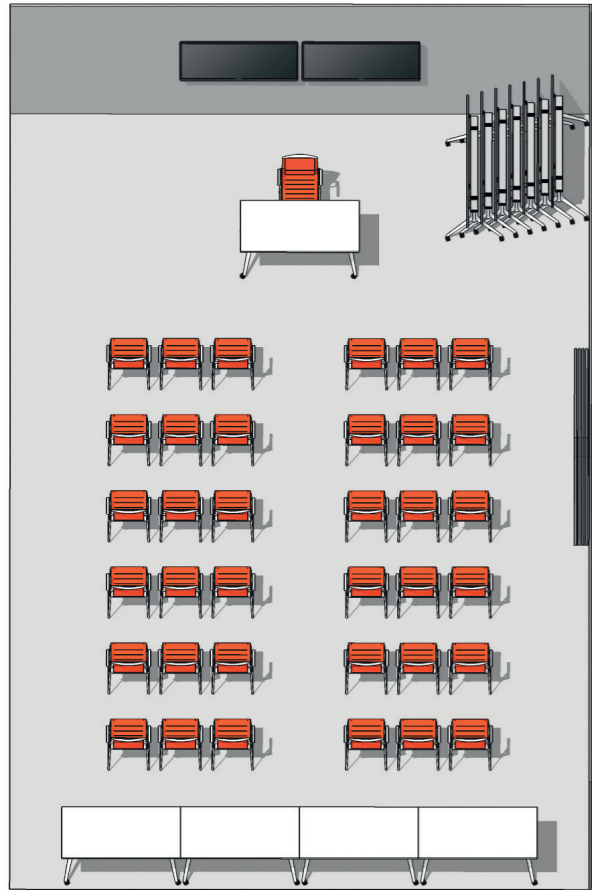

Tuesday - training room

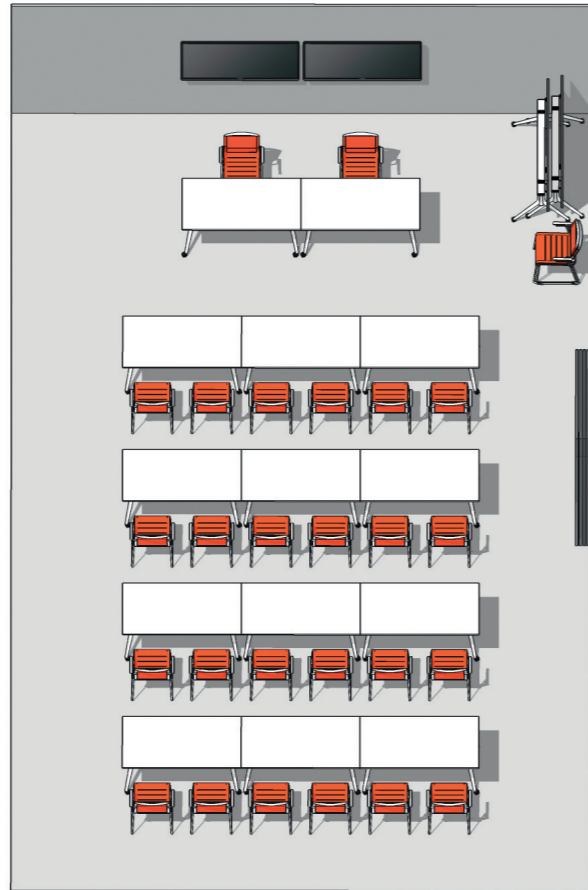

Wednesday - meeting room

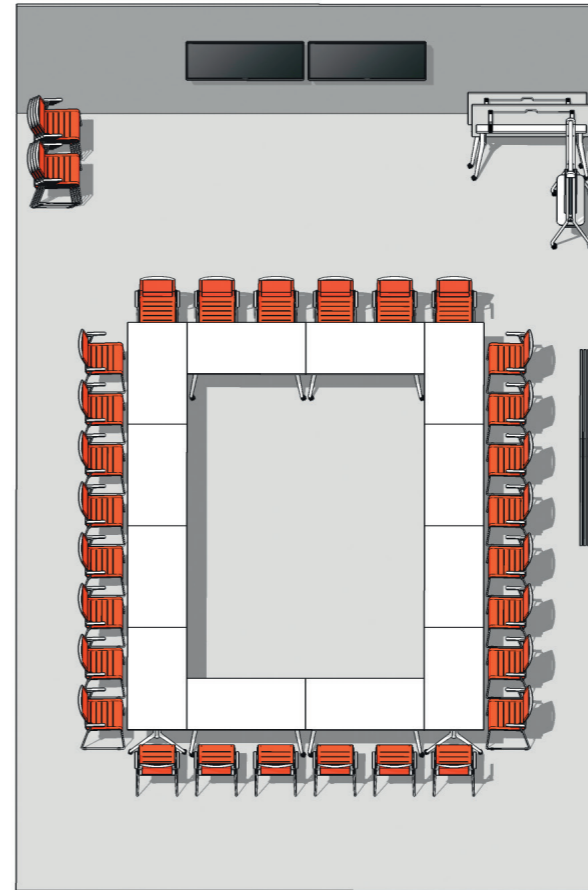

Friday - multiple use

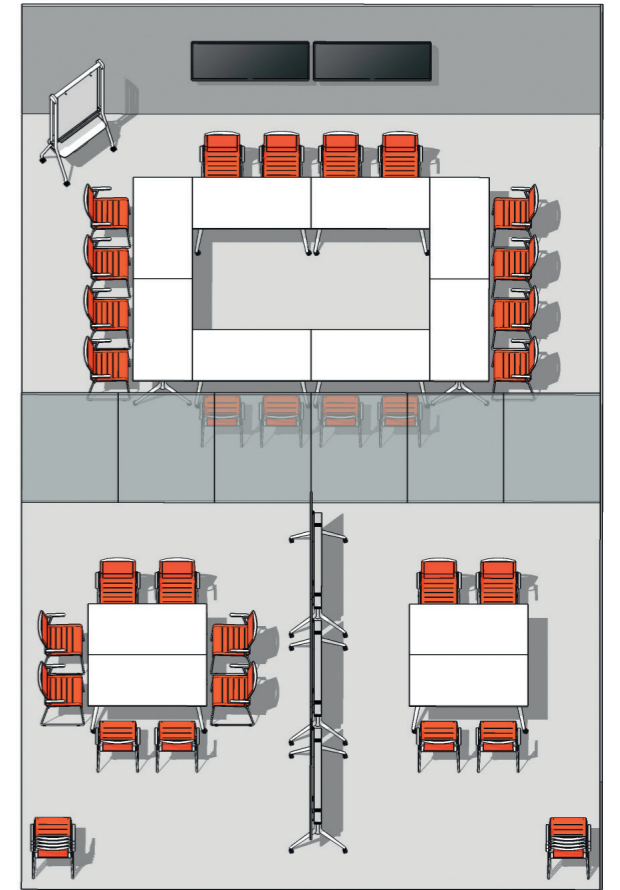

One room, many solutions **2**

Monday - meeting room

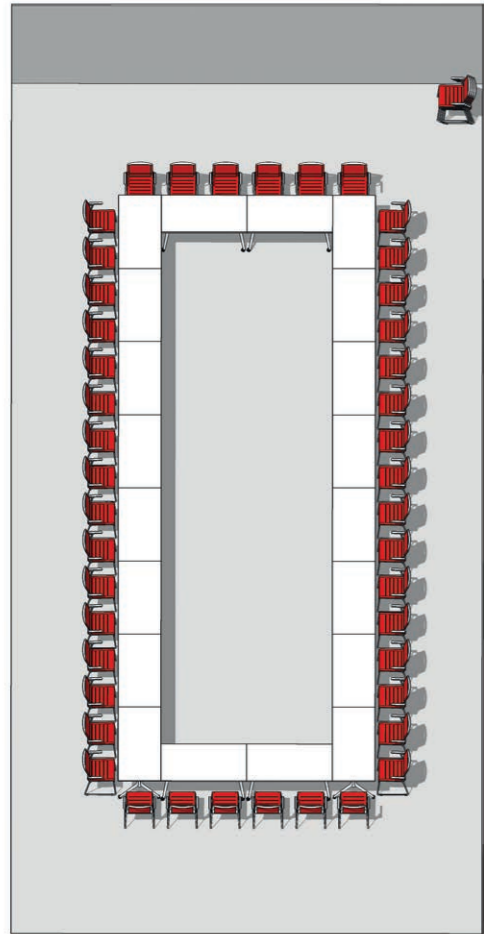

Tuesday - training room

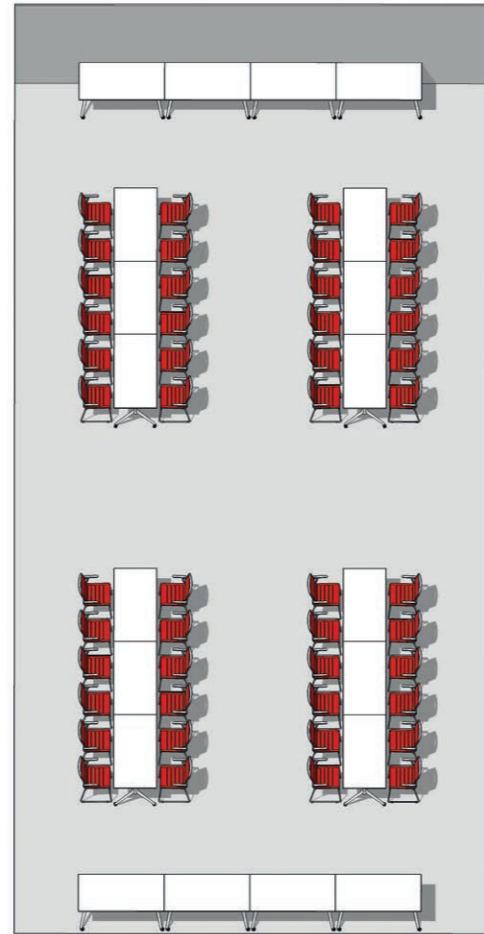

Wednesday - multiple use

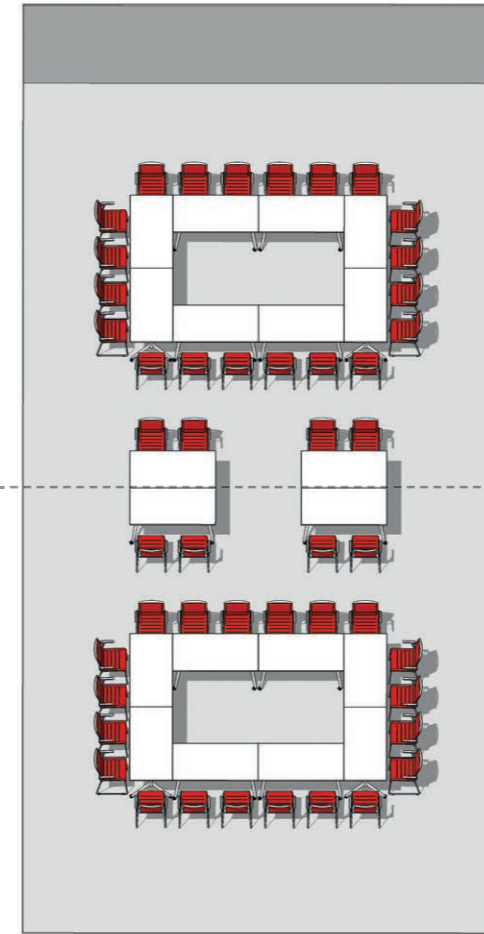

Thursday - multiple use

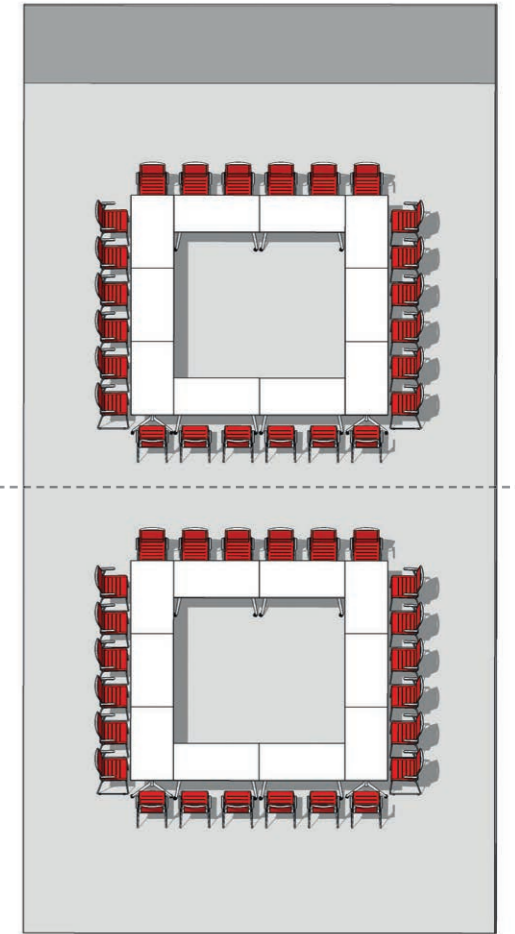

One room, many solutions **3**

Tuesday - multiple use

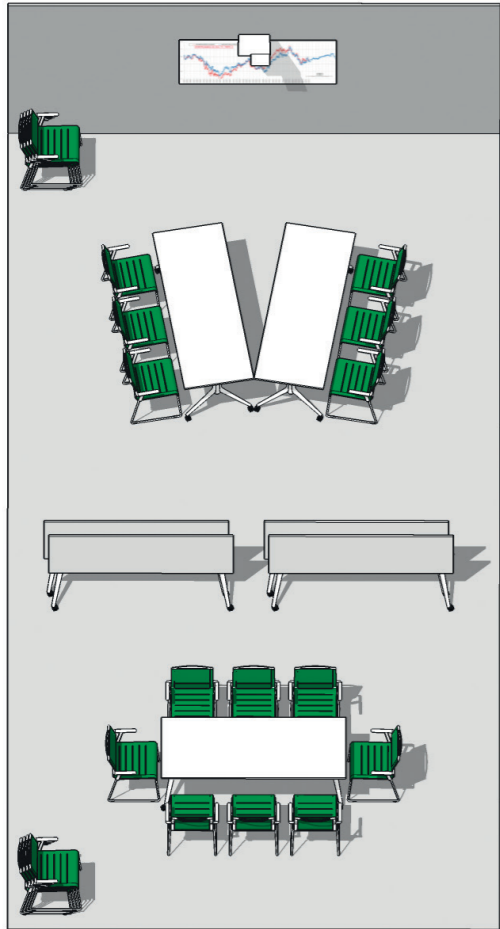

Wednesday - meeting room

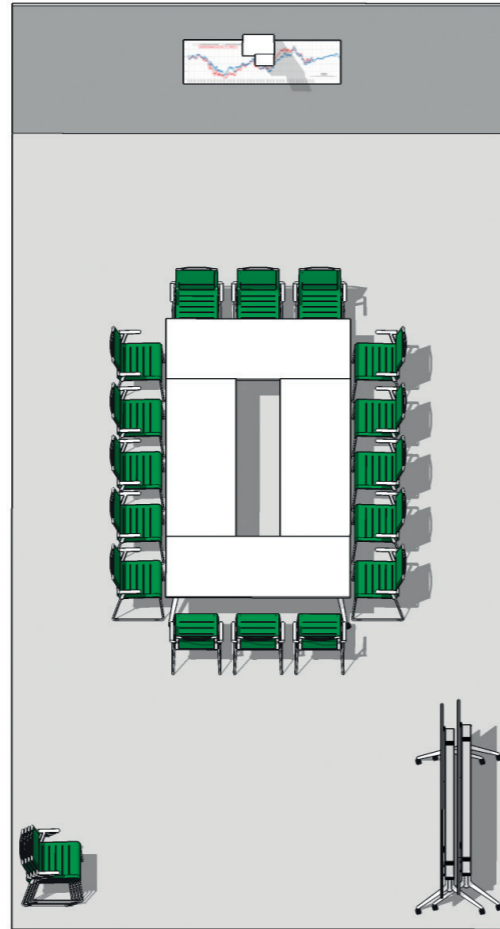

Thursday - training room

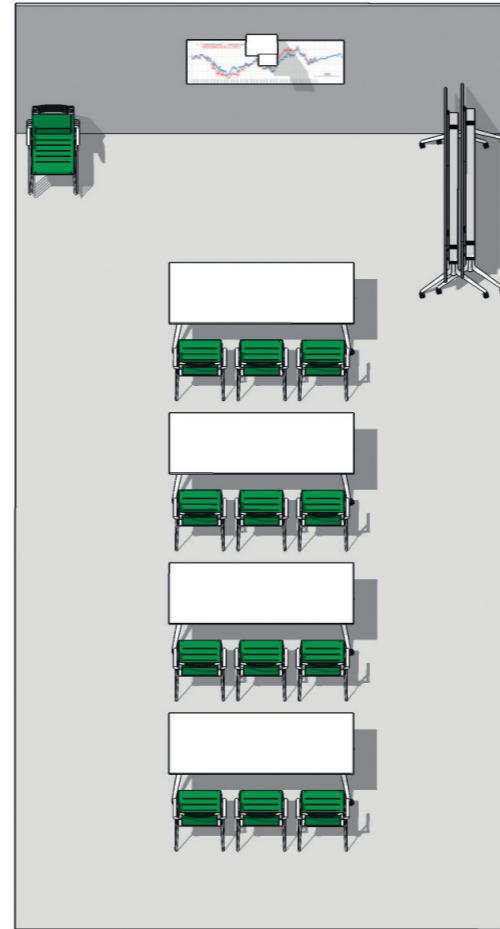

Friday - meeting room

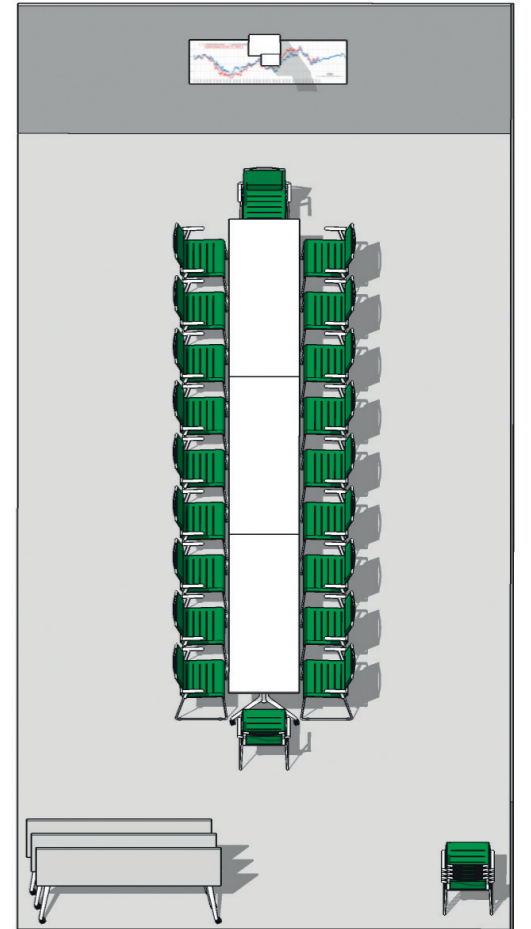

One room, many solutions **4**

January - desk

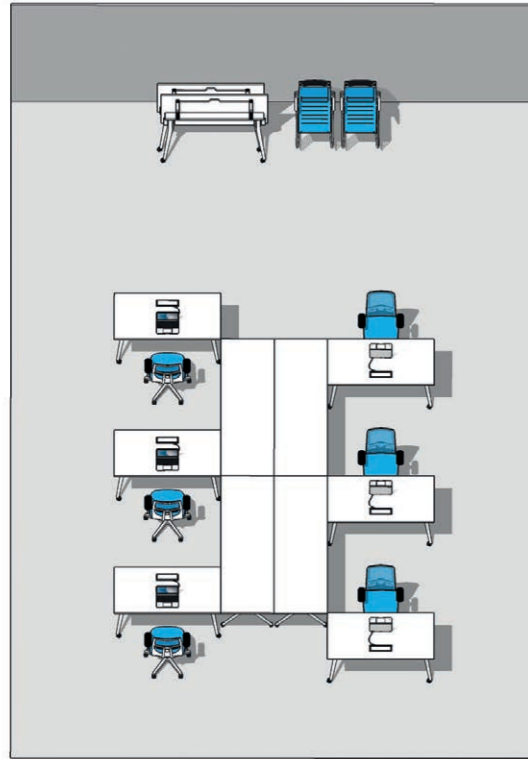

February - meeting

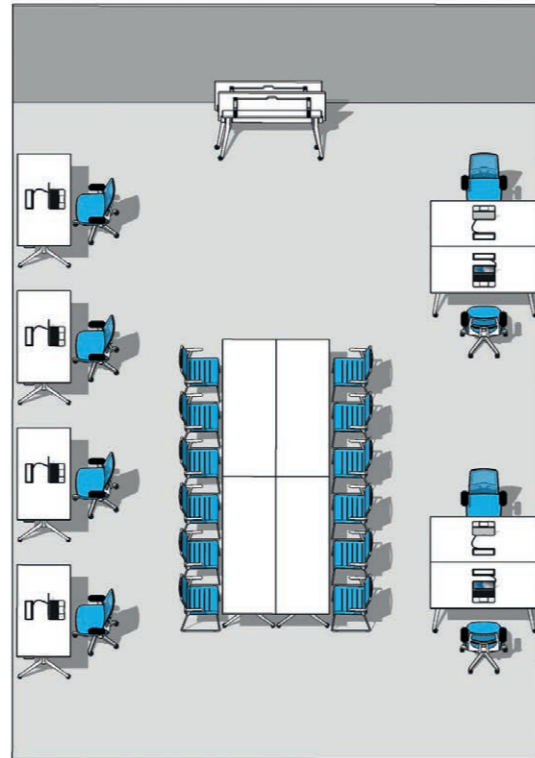

June - multi office

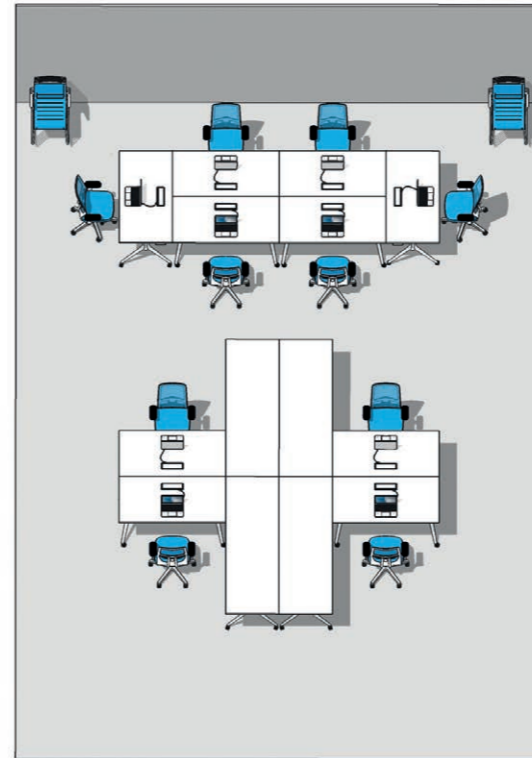

December - operative desk

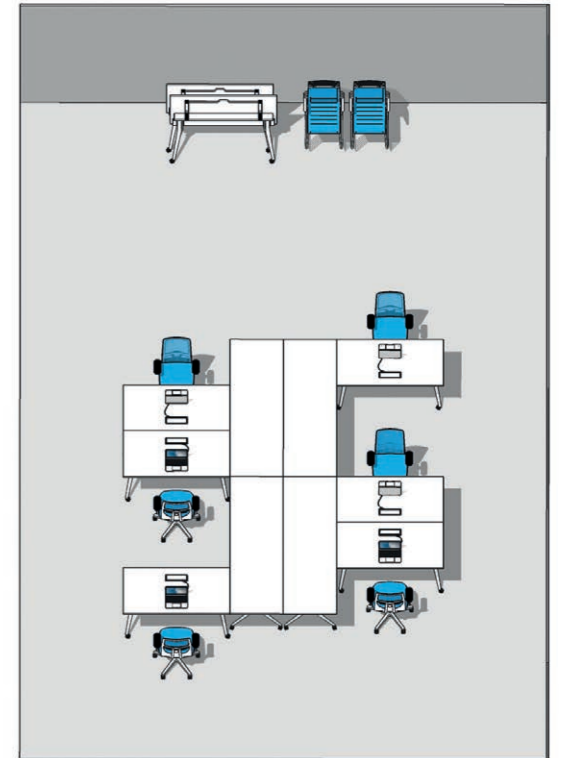

NoTable
OPERATIVE DESK

Your own space **up to you**

A project designed around new ways of working in the office environment: flexible and dynamic, innovative and modern. NoTable is a system of tables which offers countless interpretations: it responds to a variety of professional needs with maximum efficiency to become an executive desk, a double desk, a multi-station work area, and a meeting table of various sizes.

NoTable è un progetto che si presta a molteplici interpretazioni: può essere una efficiente ed elegante scrivania singola, oppure può diventare un tavolo di grandi dimensioni, pensato per le esigenze dei moderni spazi di lavoro collettivo: il frame e le gambe sono già predisposti per il cablaggio dei cavi, in modo da alloggiare e nascondere i vari fili solitamente presenti negli uffici. La funzionalità è un contenuto fondamentale.



NoTable
OPERATIVE DESK





ICF S.p.A.

icf@icf-office.it | www.icf-office.it
Via Cassanese, 108 - 20060 Vignate (MI)
t. +39 02 9508031 | f. +39 02 95364012